

REV	DESCRIPTION	DATE	BY	REV	DESCRIPTION	DATE	BY
G	CHANGE C. PLA & BENT LEAD FF: 32L 7X7 FR 0.08 [.003] & FR 0.15 [.006] 44L 10X10 FR 0.08 [.003] & FR 0.15 [.006] 52L 10X10 FR 0.08 [.003] 64L 14X14 FR 0.08 [.003] & FR 0.15 [.006] 80L 14X14 FR 0.08 [.003]	22AUG01	ANANG/PD	A	INITIAL RELEASE	07OCT94	
				B	CHANGE TITLE & COMPLETE REDRAW	27MAY97	RICO/PD
				C	ADD NEW LEAD COUNT - 44L 10X10 mm BODY	04JAN99	RICO/PD
H	ADD 128L LQFP 14x14x1.4	30JAN02	ANANG/PD	D	COMPLETE REDRAW & CHANGE TITLE	09JUN99	ANANG/PD
J	ADD 48L LQFP 12x12x1.4	15MAY02	ANANG/PD	E	CHANGE COMPANY NAME AND LOGO ADD 12X12 & 24X42 BODY SIZE IN THE VARIATION TABLE	22MAY00	ANANG/PD
K	CHANGE DRAFT ANGLE FR 12±1' TO 12' TYP	09JUL02	ANANG/PD	F	ADD NOTE, 52L (10x10), 80L & 120L (14x14)	16JAN01	ANANG/PD

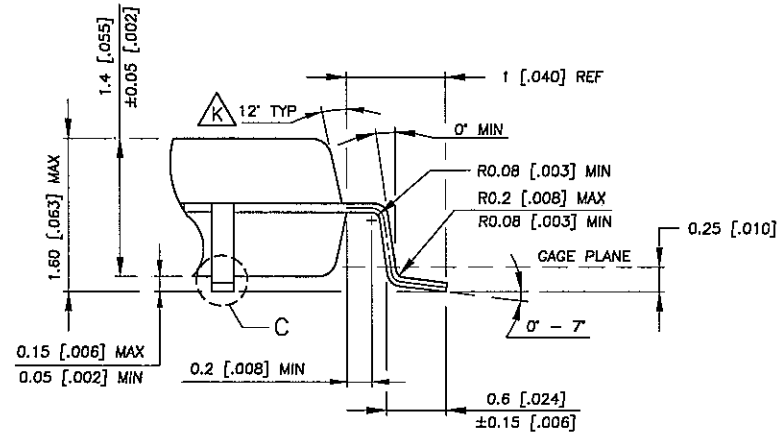

DETAIL "B"

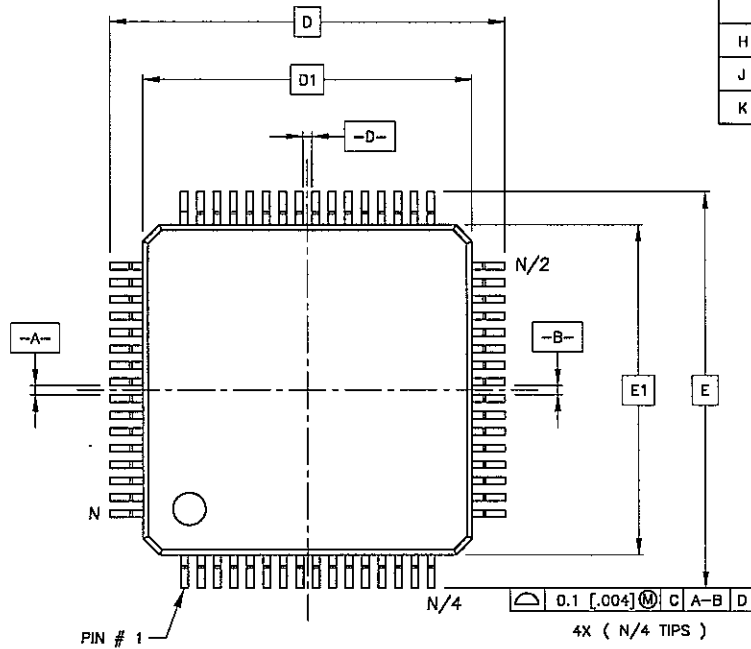
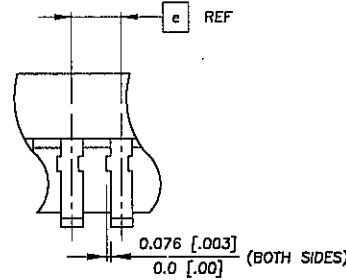
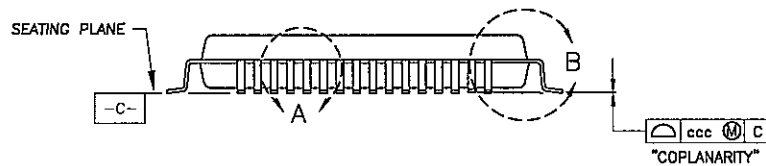

DETAIL "A"

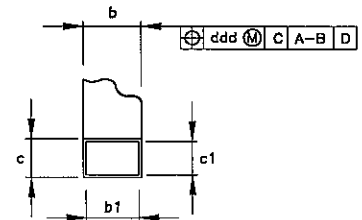

DETAIL "C"

NOTES :

- DIMENSIONS D1 AND E1 DO NOT INCLUDE MOLD PROTRUSION. ALLOWABLE PROTRUSION IS 0.25 [.010] PER SIDE. D1 AND E1 ARE MAXIMUM PLASTIC BODY SIZE DIMENSIONS INCLUDING MOLD MISMATCH.
- THE TOP PACKAGE BODY SIZE MAY BE SMALLER THAN THE BOTTOM BODY SIZE BY AS MUCH AS 0.15 [.006].
- DRAWING CONFORMS TO JEDEC MS-026 REV. A.
- COTROLLING DIMENSION IN MM.







PROJECTION FIRST ANGLE	UNIT MM [INCH]	 Advanced Interconnect Technologies	Jalan S. Perman Kav. 201 Batamindo Industrial Park, Muka Kuning Batam Island 29433, Indonesia Telp:(62)-770-611888 Fax:(62)-770-611555
APPROVAL <i>[Signature]</i>	DATE 09JUL02	TITLE FINISHED LQFP PACKAGE OUTLINE DRAWING	
DRAWN ANANG	CHECKED LITO	APPROVED ALLAN	RELEASED DOCON
DRAWING NO. DG 4966		REV. K	
SCALE DO NOT SCALE		SHEET 1 OF 3	

SYMBOL	7x7						10x10						12x12								
	MIN	NOM	MAX	MIN	NOM	MAX	MIN	NOM	MAX	MIN	NOM	MAX	MIN	NOM	MAX	MIN	NOM	MAX	MIN	NOM	MAX
D	8.8	9	9.2	8.8	9	9.2	11.8	12	12.2	11.8	12	12.2	11.8	12	12.2	13.9	14	14.1	13.9	14	14.1
	.346	.354	.362	.346	.354	.362	.464	.472	.480	.464	.472	.480	.464	.472	.480	.547	.551	.555	.547	.551	.555
D1	6.9	7	7.1	6.9	7	7.1	9.9	10	10.1	9.9	10	10.1	9.9	10	10.1	11.9	12	12.1	11.9	12	12.1
	.272	.276	.280	.272	.276	.280	.390	.394	.398	.390	.394	.398	.390	.394	.398	.469	.472	.476	.469	.472	.476
E	8.8	9	9.2	8.8	9	9.2	11.8	12	12.2	11.8	12	12.2	11.8	12	12.2	13.9	14	14.1	13.9	14	14.1
	.346	.354	.362	.346	.354	.362	.464	.472	.480	.464	.472	.480	.464	.472	.480	.547	.551	.555	.547	.551	.555
E1	6.9	7	7.1	6.9	7	7.1	9.9	10	10.1	9.9	10	10.1	9.9	10	10.1	11.9	12	12.1	11.9	12	12.1
	.272	.276	.280	.272	.276	.280	.390	.394	.398	.390	.394	.398	.390	.394	.398	.469	.472	.476	.469	.472	.476
b	0.3	0.37	0.45	0.17	0.22	0.27	0.3	0.37	0.45	0.22	0.32	0.38	0.17	0.22	0.27	0.3	0.37	0.45	0.17	0.22	0.27
	.012	.015	.018	.007	.009	.011	.012	.015	.018	.009	.013	.015	.007	.009	.011	.012	.015	.018	.007	.009	.011
b1	0.3	0.35	0.4	0.17	0.2	0.23	0.3	0.35	0.4	0.22	0.3	0.33	0.17	0.2	0.23	0.3	0.35	0.4	0.17	0.2	0.23
	.012	.014	.016	.007	.008	.009	.012	.014	.016	.009	.012	.013	.007	.008	.009	.012	.014	.016	.007	.008	.009
c	0.09		0.2	0.09		0.2	0.09		0.2	0.09		0.2	0.09		0.2	0.09		0.2	0.09		0.2
	.004		.008	.004		.008	.004		.008	.004		.008	.004		.008	.004		.008	.004		.008
c1	0.09		0.16	0.09		0.16	0.09		0.16	0.09		0.16	0.09		0.16	0.09		0.16	0.09		0.16
	.004		.006	.004		.006	.004		.006	.004		.006	.004		.006	.004		.006	.004		.006
e	0.8		0.5		0.8		0.65		0.5		0.8		0.5		0.8		0.5				
	.031		.020		.031		.026		.020		.031		.020		.031		.020				
ccc	0.10		0.08		0.10		0.10		0.10		0.08		0.10		0.08		0.08				
	.004		.003		.004		.004		.004		.003		.004		.003		.003				
ddd	0.20		0.08		0.20		0.13		0.08		0.20		0.20		0.08		0.08				
	.008		.003		.008		.005		.003		.008		.008		.003		.003				
N	32			48			44			52			64			48			80		
N/2	16			24			22			26			32			24			40		
N/4	8			12			11			13			16			12			20		

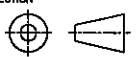

PROJECTION 	UNIT MM [INCH]		Jalan S. Parman Kav. 201 Batamindo Industrial Park, Muka Kuning Batam Island 29433, Indonesia Telp:(62)-770-611888 Fax:(62)-770-611555
APPROVAL	DATE	TITLE	
DRAWN ANANG	09JUL02	FINISHED LQFP PACKAGE OUTLINE DRAWING	
CHECKED LITO B	14 JUL 02	DRAWING NO.	REV.
APPROVED ALLAN	11 JUL 02	DG 4966	K
RELEASED DOCON	15 JUL 02	SCALE DO NOT SCALE	SHEET 2 OF 3

SYMBOL	14x14															20x20			24x24		
	MIN	NOM	MAX	MIN	NOM	MAX	MIN	NOM	MAX	MIN	NOM	MAX	MIN	NOM	MAX	MIN	NOM	MAX	MIN	NOM	MAX
D	15.8	16	16.2	15.8	16	16.2	15.8	16	16.2	15.8	16	16.2	15.8	16	16.2	21.8	22	22.2	25.8	26	26.2
D1	.622	.630	.638	.622	.630	.638	.622	.630	.638	.622	.630	.638	.622	.630	.638	.858	.866	.874	1.016	1.024	1.032
E	13.9	14	14.1	13.9	14	14.1	13.9	14	14.1	13.9	14	14.1	13.9	14	14.1	19.9	20	20.1	23.9	24	24.1
E1	.547	.551	.555	.547	.551	.555	.547	.551	.555	.547	.551	.555	.547	.551	.555	.783	.787	.791	.941	.945	.949
b	15.8	16	16.2	15.8	16	16.2	15.8	16	16.2	15.8	16	16.2	15.8	16	16.2	21.8	22	22.2	25.8	26	26.2
b1	.622	.630	.638	.622	.630	.638	.622	.630	.638	.622	.630	.638	.622	.630	.638	.858	.866	.874	1.016	1.024	1.032
c	13.9	14	14.1	13.9	14	14.1	13.9	14	14.1	13.9	14	14.1	13.9	14	14.1	19.9	20	20.1	23.9	24	24.1
c1	.547	.551	.555	.547	.551	.555	.547	.551	.555	.547	.551	.555	.547	.551	.555	.783	.787	.791	.941	.945	.949
e	0.3	0.37	0.45	0.22	0.32	0.38	0.17	0.22	0.27	0.13	0.18	0.23	0.13	0.18	0.23	0.17	0.22	0.27	0.17	0.22	0.27
ccc	.012	.015	.018	.009	.013	.015	.007	.009	.011	.005	.007	.009	.005	.007	.009	.007	.009	.011	.007	.009	.011
ddd	0.3	0.35	0.4	0.22	0.3	0.33	0.17	0.2	0.23	0.13	0.16	0.19	0.13	0.16	0.19	0.17	0.2	0.23	0.17	0.2	0.23
N	.012	.014	.016	.009	.012	.013	.007	.008	.009	.005	.006	.007	.005	.006	.007	.007	.008	.009	.007	.008	.009
N/2	0.09		0.2	0.09		0.2	0.09		0.2	0.09		0.2	0.09		0.2	0.09		0.2	0.09		0.2
N/4	.004		.008	.004		.008	.004		.008	.004		.008	.004		.008	.004		.008	.004		.008
	0.09		0.16	0.09		0.16	0.09		0.16	0.09		0.16	0.09		0.16	0.09		0.16	0.09		0.16
	.004		.006	.004		.006	.004		.006	.004		.006	.004		.006	.004		.006	.004		.006
	0.8			0.65			0.5			0.4			0.4			0.5			0.5		
	.031			.026			.020			.016			.016			.020			.020		
	0.10			0.10			0.08			0.08			0.08			0.08			0.08		
	.004			.004			.003			.003			.003			.003			.003		
	0.20			0.13			0.08			0.07			0.07			0.08			0.08		
	.008			.005			.003			.003			.003			.003			.003		
	64			80			100			120			128			144			176		
	32			40			50			60			64			72			88		
	16			20			25			30			32			36			44		

PROJECTION 	UNIT MM [INCH]	 Advanced Interconnect TECHNOLOGIES	Jalan S. Parman Kav. 201 Batamindo Industrial Park, Muka Kuning Batam Island 29433, Indonesia Telp: (62)-770-611888 Fax: (62)-770-611555
APPROVAL	DATE	TITLE	
DRAWN ANANG 	09JUL02	FINISHED LQFP PACKAGE OUTLINE DRAWING	
CHECKED LITO B 	14JUL02	DRAWING NO.	
APPROVED ALLAN 	15JUL02	DG 4966	
RELEASED DOCON 	15JUL02	SCALE DO NOT SCALE	REV. K
		SHEET	3 OF 3